

DRILL FOR COLOURS AND FLAGS

DEFINITIONS

1. **Cased Colours.** Colours enclosed in a fabric case.
2. **Colours.** Consecrated ceremonial which are carried by, and mark the identity of, Canadian Forces (CF) formations and units, and include: Queen's Colours; Standards; Guidons; and Command, College and Regimental Colours.
3. **Dipping the Colours.** Rendering a salute by lowering the Colours to the entitled dignitaries detailed in A-AD-200-000/AG-000, Honours, Flags and Heritage Structure of the CF.
4. **Flags.** Pieces of bunting or other material, attachable to a staff or halyard, and used as a means of identification or for signalling. As a generic term, it includes Colours. In this chapter it specifically means only those non-consecrated flags which may be carried on parade, i.e., Commemorative (Royal) banners, the National Flag, the CF Ensign and Command Flags.
5. **Let Fly the Colours.** Releasing the Colours to fly free, either as a salute to dignitaries not entitled to the Royal Salute as detailed in A-AD-200-000/ AG-000, Honours, Flags and Heritage Structure of the CF, or to allow free identification of the flag.
6. **Uncased Colours.** Colours removed from the fabric case.

PARADING COLOURS AND FLAGS

7. Guidelines for when Colours and flags may be carried on parade are given in A-AD-200-000/ AG-000, Honours, Flags and Heritage Structure of the CF.
8. The Colour drill in this chapter applies equally to flags when carried on parade, unless specifically noted.

DRAPING THE COLOURS

9. The Colour is draped with a piece of black crepe 2.5 m long and 33 cm wide, tied in a bow at the base of the pikehead so that the span of the bow is 30 cm. The ends, cut on the bias, should hang half-way down the sleeve of the Colour.



COMPOSITION OF A COLOUR PARTY

10. The composition of a colour party carrying one colour shall be:
 - a. Colour Officer – one junior officer (a Guidon is carried by a master warrant officer); and



- b. Colour Escorts – two sergeants (or below, if necessary);
- c. Colour orderly (corporal, drummer or private). The colour orderly usually marches in supernumerary ranks of formations near the guard until needed to attend the Colour, or wait off parade as required.

11. The composition of a Colour party carrying two Colours shall be:

- a. Colour officers – two junior officers; and
- b. Colour Escorts – one master warrant officer or warrant officer, and two sergeants (or below, if necessary);
- c. Two orderlies (corporals, drummers or privates). The colour orderlies usually march in supernumerary ranks of formations near the guard until needed to attend the Colours, or wait off parade as required.

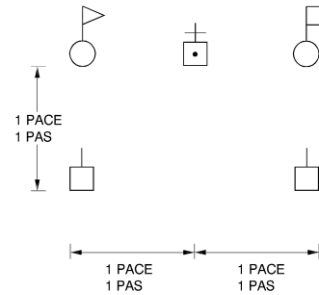

12. When a stand of Colours is carried, the Queen's Colour occupies the position of honour, i.e., on the right of the Colour party (on the left from the spectators point of view).

COMPOSITION OF A FLAG PARTY

- 13. When the National Flag, Canadian Forces(CF) Ensign or command flags are carried on parade, they shall normally be carried by senior non-commissioned officers.
- 14. Normally, the National Flag has no escort. It may be given an armed escort if the troops on parade are armed.
- 15. The CF Ensign and command flags by themselves are not entitled to, and shall not be attended by, an armed escort. They may have such an escort when paraded in company with the National Flag if it has an armed escort.
- 16. When a flag party carries the National Flag and either the CF Ensign or a command flag, the National Flag occupies the position of honour on the right (on the left from the spectators point of view).

DUTIES

- 17. **Colour Officers (master warrant officer for Guidons).** Colour officers are appointed to carry, handle and protect the Colours.
- 18. **Colour Escort.** The mission of Colour escorts is to safeguard the Colours. Once they have taken up their duty, they remain with the Colour, or with any armed "escort to the Colour", until it is safely lodged again. With an "escort to the Colour", they occupy supernumerary positions until called upon to resume their close escort duties. When Colours are ordered to take post in review order, the escorts shall stand fast.

19. **Colour Orderlies.** When Colours are to be moved cased to a ceremonial parade, a Colour orderly shall be designated for each to assist the Colour officer and take charge of the cases during the parade. In units with a corps of drums, a drummer or bugler is traditionally given this responsibility, with the drum major assisting the adjutant with ensuring that Colours and Colour belts are ready for parades. Since a drummer or bugler with Colour orderly duties is precluded from playing an instrument, any other service member may be selected in lieu.

ARMS AND EQUIPMENT

20. The Colour bearer wears the Colour belt over the left shoulder.
21. The Colour officer (or master warrant officer in the case of armoured regiments) shall be armed with a sword or a pistol.
22. The Colour escort shall be armed with bayonets fixed, the points of which may be covered with short sheathes, in order to avoid tearing the Colours.

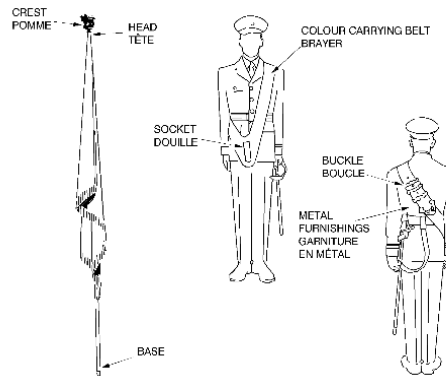

COLOUR DRILL

23. Colour drill shall be executed with a standard pause between movements in a similar manner to rifle drill.
24. A cased Colour shall be held in the order position at the halt and carried in the slope position on the march. A cased Colour is never held at the carry.
25. An uncased Colour is never sloped at the halt; it shall be at the carry or the order, according to whether arms are at the shoulder or the order.
26. On the march, an uncased Colour always shall be carried at the slope, except when on the review parade ground or when paying compliments. Then, it shall be at the carry.
27. During an inspection of personnel on parade the uncased Colour shall be at the carry.

POSITION OF THE ORDER

28. At the order:
- The Colour bearer is at attention
 - The pike is held vertical with the right hand, at the right side. The base of the pike is on the ground at the right side of the right foot, in line with the toe of the shoe.
 - The pike and Colour are held with an all-round grasp of the right hand, back of the hand outwards, at the point of the pike where the lowest corner of the Colour reaches.

- d. The Colour shall hang naturally down the pike and shall not be stretched taut.
- e. The right elbow is at the side.
- f. The right wrist is directly in rear of the pike.

29. A cased Colour is held similarly except that the case is grasped in the right hand.

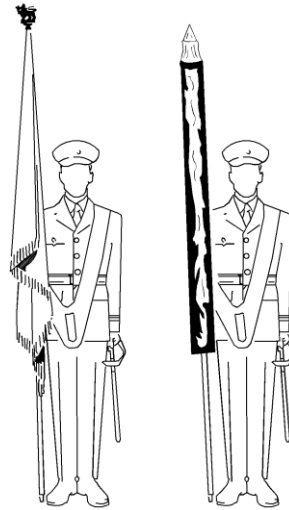

STAND AT EASE FROM THE ORDER

30. On the command STAND AT – EASE:

- a. move the left foot in the normal manner; and
- b. keep the Colour and pike unmoved in the same position as described for the order.

STAND EASY FROM STAND AT EASE

31. On the command STAND – EASY:

- a. the Colour and pike remain in the same position;
- b. the left arm is kept to the side; and
- c. the body is relaxed, but the feet and Colour are not moved.

32. The stand at ease position shall be resumed on the cautionary command SQUAD (GUARD) (etc.).

ORDER FROM STAND AT EASE

33. On the command ATTEN – TION, move the left foot in the normal manner.

CARRY FROM THE ORDER

34. On the command CARRY COLOUR(S) BY NUMBERS, SQUAD – ONE;

- a. with the right hand, raise the Colour to a vertical position in front of the centre of the body, keeping the base of the pike just clear of the socket, and the right forearm alongside the pike; and
- b. simultaneously, bring the left hand to the socket and guide the pike into the socket.

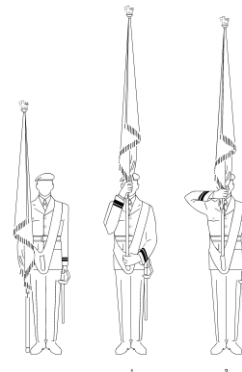

35. On the command SQUAD – TWO:

- a. bring the left hand to the position of the order;
- b. simultaneously raise the right forearm parallel to the ground; thus
- C. on completion of the movement:
 - i. the right hand is opposite the mouth,
 - ii. the right forearm is parallel to the
 - iii. ground at right angles to the pike,
 - iv. the wrist of the right arm is straight,
 - v. the back of the hand is outwards, and
 - vi. the head and eyes are facing the front.

36. On the command CARRY – COLOUR, the two movements are combined. A standard pause shall be observed between the movements.

37. When arms are carried on a parade and the parade is given the command SHOULDER – ARMS, the Colour officer shall carry the Colour in time with the rifle movements.

ORDER FROM THE CARRY

38. On the command ORDER COLOUR(S) BY NUMBERS, SQUAD – ONE:

- a. with the right hand raise the pike clear of the socket, bringing the right forearm from the horizontal position to a vertical position alongside the pike; and
- b. simultaneously, bring the left hand to the socket to steady the pike and belt.

39. On the command SQUAD – TWO:

- a. carry the Colour with the right hand to the position of the order;
- b. move the left hand across the body to steady the pike; thus
- C. on completion of the movement:
 - i. the back of the left hand shall be outwards,
 - ii. the fingers of the left hand are extended and pointing to the right, and
 - iii. the left forearm is parallel to the ground.

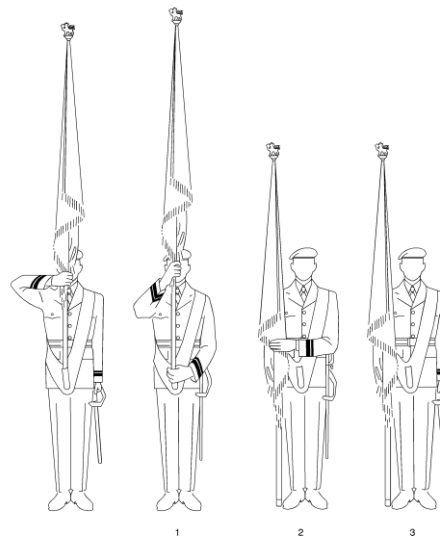

40. On the command SQUAD – THREE, cut the left hand to the side in the position of attention.

41. On the command ORDER – COLOUR, the three movements are combined. A standard pause shall be observed between the movements.

42. When arms are carried on a parade and the parade is given the command ORDER – ARMS, the Colour officer shall order the Colour in time with the rifle movements, unless the command is given just prior to an inspection, when the Colour officer shall remain at the carry.

SLOPE FROM THE CARRY

43. On the command SLOPE COLOUR(S) BY NUMBERS, SQUAD – ONE:
- with the right hand raise the pike clear of the socket, bringing the right forearm from the horizontal position to a vertical position alongside the pike; and
 - simultaneously, bring the left hand to the socket to steady the pike and the belt.

44. On the command SQUAD – TWO:
- lower the Colour with the right hand to the right shoulder;
 - simultaneously, with the left hand grasp the pike above the right hand with an all-round grip, to steady the pike; thus
 - on completion of the movement:
 - the Colour shall be at a 45 degree angle on the right shoulder,
 - the elbow shall be close to the body,
 - the right forearm should be in a comfortable position parallel to the ground,
 - the Colour shall hang over and cover the right shoulder and arm, and
 - the pike shall not show between the hand and the shoulder and shall be covered by the Colour.

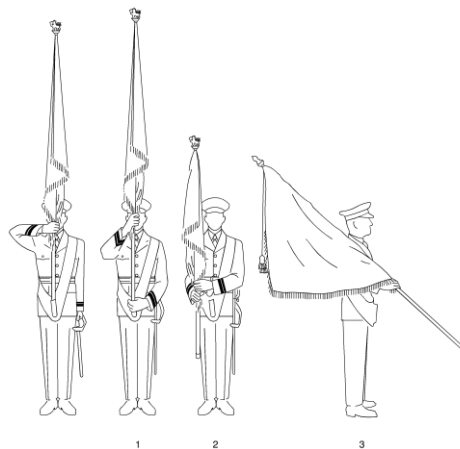

45. On the command SQUAD – THREE, cut the left hand to the side assuming the position of the order.

46. On the command SLOPE – COLOUR, the three movements are combined. A standard pause shall be observed between the movements.

47. Upon departing the review parade ground or after paying compliments elsewhere, an uncased Colour normally should be returned to the slope in the following manner:
- On the command QUICK – MARCH, the Colour officer shall slope the Colour from the carry, executing the first movement on the first pace with the left foot and the remaining movements on successive paces with the left foot.
 - When the senior Colour officer gives the command SLOPE – COLOUR, after paying compliments on other than a review parade ground, the command is given on the left foot and the movements executed as above. When only one Colour is carried, the Colour officer shall carry out the movements without word of command.

SLOPE FROM THE ORDER (CASED COLOUR)

48. On the command SLOPE COLOUR(S) BY NUMBERS, SQUAD – ONE:
- with the right hand raise the pike clear of the ground and place it on the right shoulder; and

- b. simultaneously, with the left hand grasp the pike above the right hand with an all-round grip, to steady the pike.

49. On the command SQUAD – TWO, cut the left hand smartly to the side, assuming the position of attention.

50. On the command SLOPE – COLOUR, both movements are combined, with a standard pause between movements. On the completion of the drill the Colour shall be at a 45 degree angle on the right shoulder, the right elbow close to the body and the right forearm in a comfortable position parallel to the ground.

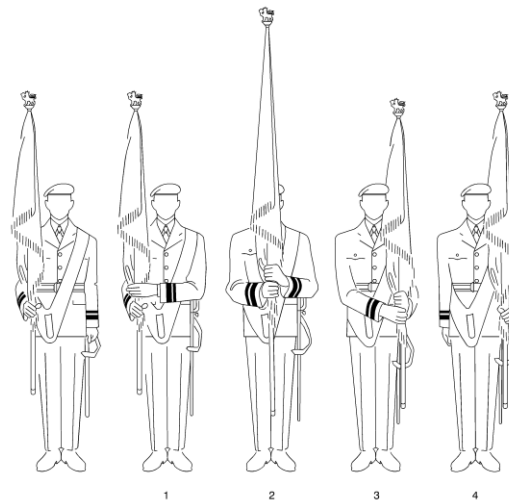

ORDER FROM THE SLOPE (CASED COLOUR)

51. On the command ORDER COLOUR(S) BY NUMBERS, SQUAD – ONE:

- a. with the right hand lower the pike to the ground by straightening the right arm down the right side; and
- b. simultaneously, bring the left arm smartly across the body, keeping the forearm parallel to the ground and steady the Colour by cupping the left hand around the case.

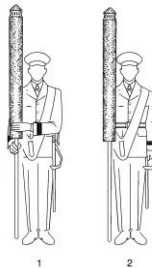

52. On the command SQUAD – TWO, cut the left arm smartly to the side, assuming the position of attention.

53. On the command ORDER – COLOUR, both movements are combined, with a standard pause between movements.

CHANGING THE COLOUR AT THE SLOPE

54. On the command CHANGE COLOUR(S) BY NUMBERS, SQUAD – ONE:

- a. grasp the pike with the left hand above the right, in an all-around grip, back of the hand to the front, and thumb to the rear; and
- b. keep the elbows close to the body.

55. On the command SQUAD – TWO:

- a. carry the Colour, with the pike perpendicular, to a position 10 cm in front of the centre of the body; and

- b. keep the elbows close to the body and both forearms parallel to the ground.

56. On the command SQUAD – THREE, place the Colour on the left shoulder, retaining the grip of both hands on the pike in a similar position to that described for the first movement above, except that the back of the right hand is now to the front.

57. On the command SQUAD – FOUR, cut the right hand to the side.

58. On the command CHANGE – COLOUR, combine the four movements, observing a standard pause between the movements.

59. To change Colour from the left to the right, the drill above is reversed.

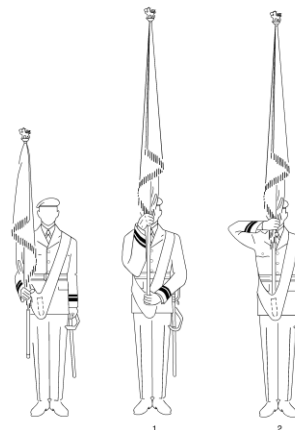

CARRY FROM THE SLOPE

60. On the command CARRY COLOUR(S) BY NUMBERS, SQUAD – ONE:

- a. raise the Colour off the right shoulder with the right hand to the perpendicular position of the carry from the order; and
- b. simultaneously, bring the left hand to the socket to guide the base of the pike into the socket.

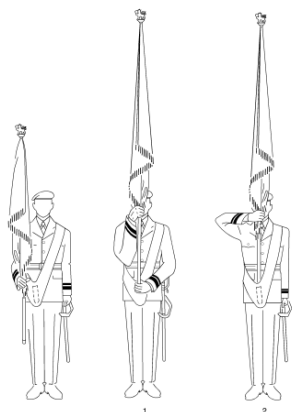

61. On the command SQUAD – TWO, cut the left hand to the side and assume the carry position.

62. On the command CARRY – COLOUR, the two movements are combined. A standard pause shall be observed between the movements.

LET FLY FROM THE CARRY

63. On the command LET FLY THE – COLOUR(S), maintaining the grip on the pike, release the Colour with a downward movement of the right hand.

64. When arms are carried on parade and the order GENERAL SALUTE, PRESENT – ARMS is given, the Colour shall be let fly on the first movement of the present arms.



65. During the march past in quick time, on the command EYES – RIGHT, the Colour is let fly on the next left foot.

66. On the command EYES – FRONT, the Colour is caught.

CATCHING THE COLOUR FROM THE LET FLY

67. On the command CATCH THE COLOUR(S) BY NUMBERS, SQUAD – ONE:

- a. grasp the Colour with the left hand and bring it in to the pike; and
- b. simultaneously, grasp the corner of the Colour with the right hand, back of the hand outwards, at the point of the pike where the lowest corner of the Colour reached.

68. On the command SQUAD – TWO, cut the left hand to the side to the position of attention and raise the right forearm to the horizontal position.

69. On the command CATCH THE – COLOUR, the two movements are combined. A standard pause shall be observed between the movements.

70. Depending on the wind direction, the Colour may be grasped with the right hand after securing the pike in the left hand. If, because of wind strength, the Colour cannot be caught, the Colour shall be brought to the position of the order, the Colour secured and returned to the carry. The same drill is executed while marching.

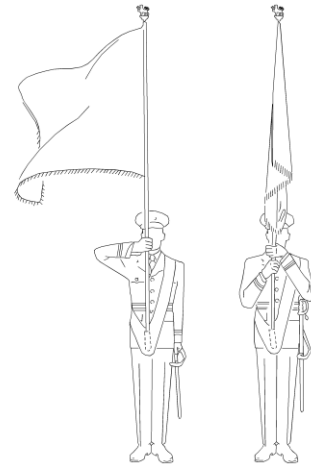

71. When arms are carried on parade and the parade is ordered to shoulder arms from the present, the Colour officer shall carry out the movements in time with the rifle movements.

DIP FROM THE CARRY AT THE HALT

72. On the command DIP THE COLOUR(S) BY NUMBERS, SQUAD – ONE:

- a. releasing the Colour from the pike, raise the pike to the full extent of the right arm; and
- b. simultaneously, bring the left hand across the body and grasp the socket to steady the Colour belt.

73. On the command SQUAD – TWO:

- a. maintaining control of the base of the pike with the right armpit, carry the pike well out to the right with the right hand and lower it with a sweeping motion to a position in front of the right foot;
- b. simultaneously, cut the left hand to the

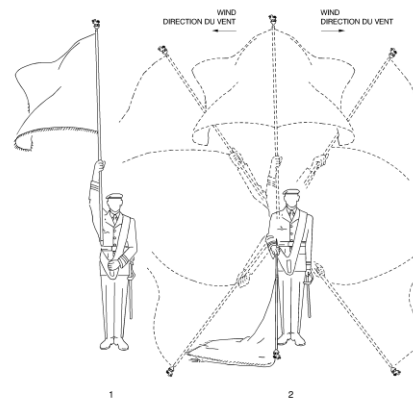

side to the position of attention; thus

- C. on completion of the movement:
- i. the pikehead shall be just clear of the ground,
 - ii. the Colour shall be spread on the ground to the right of the pike, and
 - iii. the pike shall be held under the right armpit, the back of the right hand towards the ground.

74. On the command DIP – COLOUR, the two movements are combined. A standard pause shall be observed between the movements.

75. If the ground is wet or muddy, the pikehead shall be 5 cm above the ground. The Colour shall be held in the left hand to prevent it from being soiled.

76. If a strong wind is blowing from the right, the pike shall be carried with the right hand well to the left, and then lowered with a sweeping motion to the position of the dip. The Colour shall be spread to the left of the pike.

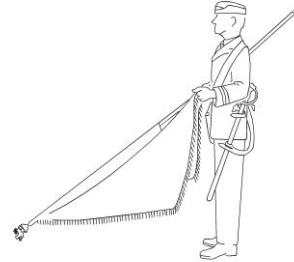

77. When arms are carried on parade and the order ROYAL SALUTE, PRESENT – ARMS is given, the Colour officer shall commence both movements of the dip in time with the rifle movements.

CARRY FROM THE DIP AT THE HALT

78. On the command CARRY COLOUR(S) BY NUMBERS, SQUAD – ONE:

- a. raise the Colour with the right hand, to the perpendicular position of the carry;
- b. simultaneously, bring the left hand to the socket to guide the base of the pike into the socket.

79. On the command SQUAD – TWO:

- a. grasp the Colour with the left hand and bring it in to the pike; and
- b. simultaneously, grasp the corner of the Colour with the right hand as for the carry.

80. On the command SQUAD – THREE, cut the left hand to the side and assume the position of the carry.

81. On the command CARRY – COLOUR, the three movements are combined. A standard pause shall be observed between the movements.

82. When arms are carried on parade and the parade is ordered, SHOULDER – ARMS, following the command ROYAL SALUTE, PRESENT – ARMS, the Colour officer shall execute the first two movements of the carry from the dip, at the halt, in time with the two movements of the shoulder arms.

DIP FROM THE CARRY ON THE MARCH

83. The dip is only executed on the march in slow time.
84. On the command EYES – RIGHT given as the left foot is forward and on the ground, the Colour shall be let fly on the next pace with the left foot. On the following pace with the left foot:
- grasp the socket with the left hand; and
 - raise the pike clear of the socket with the right hand.
85. On the next pace with the left foot:
- maintaining control of the base of the pike under the right armpit, move the Colour in a sweeping motion to the right and lower the pike to a horizontal position directly in front; and
 - simultaneously, cut the left hand to the side.
86. On completion of the movement:
- the back of the right hand shall be towards the ground;
 - the right elbow shall be close to the side;
 - the Colour shall hang straight down;
 - the left arm shall be straight at the side; and
 - the head and eyes shall be straight to the front.

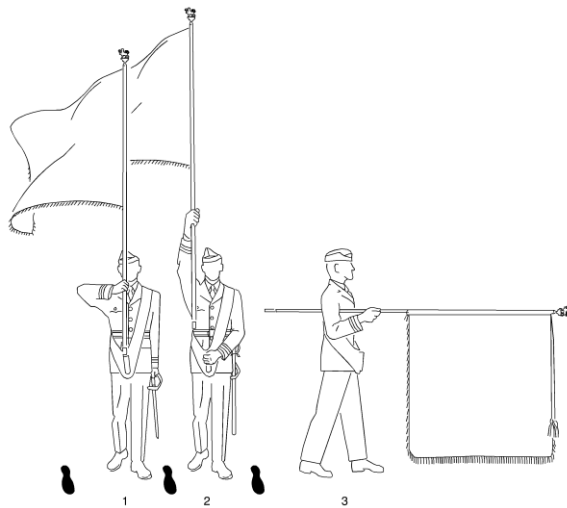

CARRY FROM THE DIP ON THE MARCH

87. On the command EYES – FRONT, on the next pace with the left foot:
- raise the Colour with the right hand, to the perpendicular position of the carry;
 - simultaneously, bring the left hand to the socket to guide the base of the pike into the socket.
88. On the following pace with the left foot, the Colour shall be caught with the left hand, and the corner of the Colour shall be grasped with the right hand.
89. On the next pace with the left foot, cut the left hand to the side.
90. If the wind is strong, the Colour may be secured as noted in paragraph 70.

CASING THE COLOURS

91. After being marched off parade, unless the place for lodging is close-by, the Colour party moves to the side of the parade ground and takes up a position facing the flank of the unit. The Colour orderlies fall in side by side, three paces to the left of the Colour party.
92. The Colour officers come to the order and the senior orders CASE THE – COLOUR(S).
93. On this command, the Colour orderlies move to a position four paces in front of and facing their respective Colour, halt, salute, take one pace forward and raise their left forearm parallel to the ground, cupping the left hand.
94. The Colour officers lower the pikes, directly forward, to a horizontal position, as for the last movement of the dip on the march, bringing the crests to rest in the orderlies, cupped left hands.
95. The Colour officers, with the left hand, and the orderlies, with the right hand, grasp the bottom corner of the Colour nearest to them and together fold the bottom edge of the Colour over the pike, ensuring that the fringe also hangs over the pike. The above procedure is executed three times, ensuring that there are no creases and that the Colours are neatly rolled along the top of the pike. As the Colour is folded, successive folds are held in place by the right thumb of the Colour officer and the left thumb of the orderly. The orderlies then wrap the tasselled cords around the Colours three times along their width. The Colour officers grasp the ends of the cords and the Colour in their left hand.
96. The orderlies remove the cases from their left forearms and carefully slide them over the Colours. As the cases are slid to the bottom of the Colours, the Colour officers, with their left hand, assist in pulling the cases fully over the Colours. The officers then tie the laces while the orderlies steady the horizontal pikes. When finished, Colour officers then cut their left arms sharply to the side.
97. When the cases are in place, the orderlies resume their original position, cupping the caps in their left hand, and, upon a signal from the Colour officers, give the pikes an upward thrust with the left hand, assisting the officers to return the Colours to the order position. The orderlies cut their left arms smartly to the side.
98. The orderlies step back to their original position, salute, turn right and march off the parade ground.
99. The Colour party, under command of the senior Colour officer, returns the Colours to their lodging.

UNCASING THE COLOUR

100. On arrival at the parade ground, the Colour party positions itself on the nearest flank of the parade, the orderlies falling in three paces to the left of the Colour party.
101. The senior Colour officer, at the order position, commands UNCASE THE – COLOUR(S).

102. On this command, the Colour orderlies move to a position four paces in front of, and facing, their respective Colour. They halt, salute, take one pace forward and raise their left forearm parallel to the ground, cupping the left hand.

103. The Colour officers lower the pikes directly forward to a horizontal position, as for the last movement of the dip on the march. The caps are brought to rest in the cupped left hands of the orderlies.

104. The Colour officers untie the tapes of the case and grasp the Colours with their left hand inside the case. The orderlies carefully remove the cases and place them over their left forearm, the caps to the left.

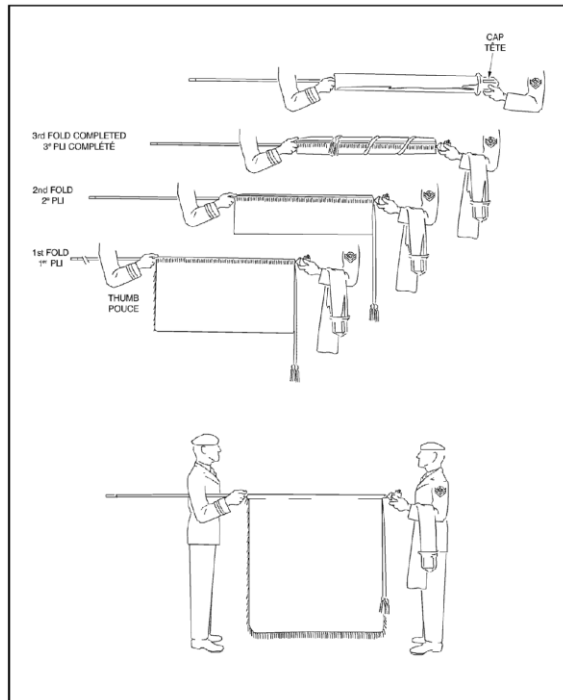

105. The senior Colour officer shall then order COLOUR PARTY, TO THE COLOUR, PRESENT – ARMS.

106. The orderlies then unroll the cords, the Colour officers release the Colour and cut the left arms smartly to the side. The Colour orderlies then ensure that the Colours and cords hang correctly.

107. On a signal from the Colour officers, the orderlies give the pikes an upward thrust, assisting the officers to return the Colours to the order position. The orderlies then cut their arms smartly to the side.

108. The Colour officers dress the Colours to ensure that they are evenly distributed on both sides of the pike. The orderlies assist if required.

109. The orderlies step back to their original position, salute, turn right and march off the parade ground to a pre-designated location.

110. The senior Colour officer then shall order COLOUR PARTY, SHOULDER – ARMS.

MARCHING ON THE COLOUR

111. Colours shall be held at the carry while being marched on and off parade.

112. On the command MARCH ON THE COLOUR(S), given by the parade commander, the following shall take place:

- a. the senior Colour officer shall order the cautionary COLOUR PARTY;
 - b. the parade commander shall order TO THE COLOUR(S), PRESENT – ARMS;
 - c. the senior Colour officer shall order BY THE RIGHT (CENTRE), QUICK – MARCH. If a band is on parade, it shall play appropriate music.
113. The Colour party shall march to its position by a series of forms. Upon halting in its parade position, the senior Colour officer orders COLOUR PARTY, TO THE COLOUR(S), PRESENT – ARMS.
114. Once the Colour escort is at the present, the parade commander orders SHOULDER – ARMS, and the parade, now including the Colour party, shoulders arms.
115. Until it is ordered off at the conclusion of the parade, the Colour party shall act normally on the parade commander's command, except in the following circumstances:
- a. During an inspection, the Colour shall be held in the carry position. When required to move to a flank independently, the Colour party shall do so under command of its senior Colour officer by executing forms at the halt or on the march.

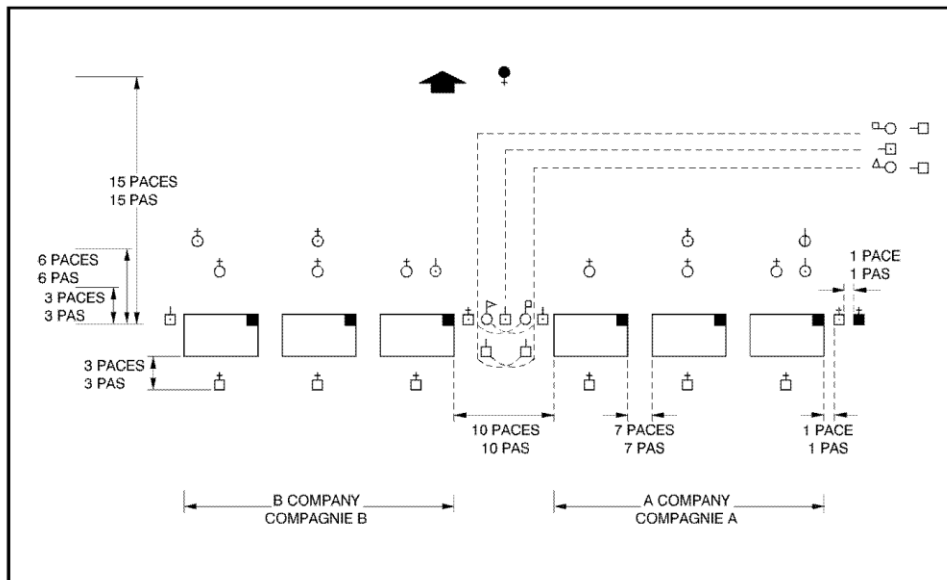

MARCHING OFF THE COLOUR

116. On the conclusion of the parade, the parade commander shall order MARCH OFF THE – COLOUR(S).
117. The senior Colour officer shall order the cautionary COLOUR PARTY. The parade commander shall order TO THE COLOUR(S), PRESENT – ARMS.
118. The senior Colour officer shall order BY THE RIGHT (CENTRE), QUICK – MARCH. If a band is present, it shall play appropriate music.

119. The Colour party, by forming, shall march off the parade ground to the left or right flank.

POSITION OF COLOURS ON BATTALION PARADE

120. The Colours shall be positioned in the centre of the battalion as described below. If the battalion has an odd number of companies on parade, the Colours shall be positioned in the first interval between companies toward the honour side of the battalion's centre, i.e., to the right in line and mass, and to the front in column of companies.

121. **Battalion in Line.** The Colours shall be positioned between the two centre companies as follows:

- a. **One Colour.** The Colour officer is positioned in line with the front rank and the escort in line with the rear rank.
- b. **Two Colours.** The Colour officers and Colour warrant officer are positioned in line with the front rank and the sergeants with the rear rank (Figure above in marching on the colours.)

122. **Battalion Retired.** If the battalion is ordered to retire, the Colour party will turn about, but will remain steady in its original alignment.

123. **Battalion in Column of Route/Column of Threes.** The Colours shall be positioned between the two centre companies as follows:

- a. **One Colour.** The Colour officer covers off the centre file of the battalion and the Colour escorts cover off the flank files.
- b. **Two Colours.** The Colour officers and the Colour escorts cover off the flank files of the battalion and the warrant officer covers off the centre file.

124. **Battalion in (Close) Column of Companies.** The Colour party shall be positioned between the centre companies, in rear of the company to its front, and when marching past, the following positioning will be observed:

- a. **One Colour.** Alignment shall be with the supernumerary rank of the company in front.
- b. **Two Colours.** The two sergeants shall take post by moving up on the right and left of the Colours respectively, the whole party being aligned with the supernumerary rank of the company in front

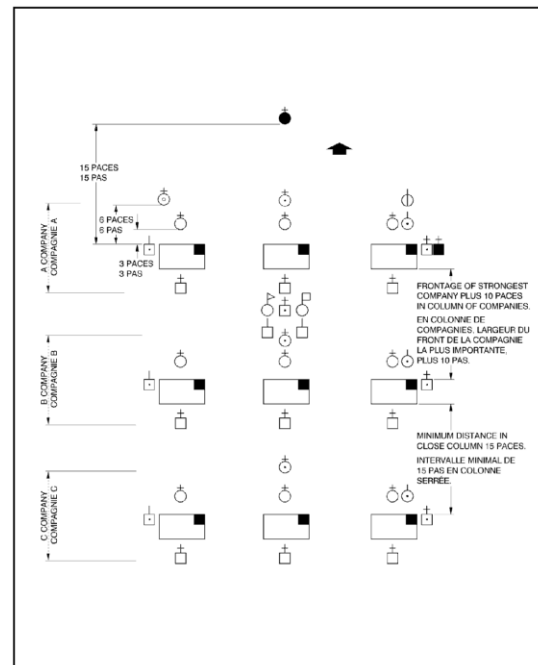

125. **Battalion in Mass.** The Colour party shall be positioned between the two centre companies as follows:

- a. **One Colour.** The Colour officer is positioned in line with the front rank of the leading platoons and the escorts in line with the rear rank of these same platoons.
- b. **Two Colours.** The Colour officers and the Colour warrant officer are positioned in line with the front rank of the leading platoons and the sergeants in line with the rear rank of these same platoons.

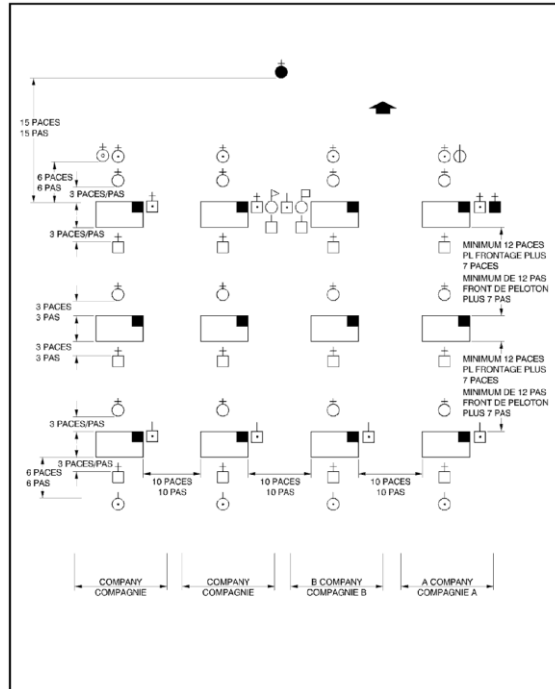

126. **Review Order.** The Colour bearers shall advance with the rest of the parade 7 or 14 paces.

GUARDS OF HONOUR

127. When paraded with a guard of honour, Colours shall be positioned in review order prior to the arrival of the dignitary for whom the guard is being mounted.
128. When flags are paraded with a guard of honour, they maintain position and are not advanced in review order.